

TOP VIEW OF UNITY SURFACING SYSTEMS TRANSITION RAMP (LONG)

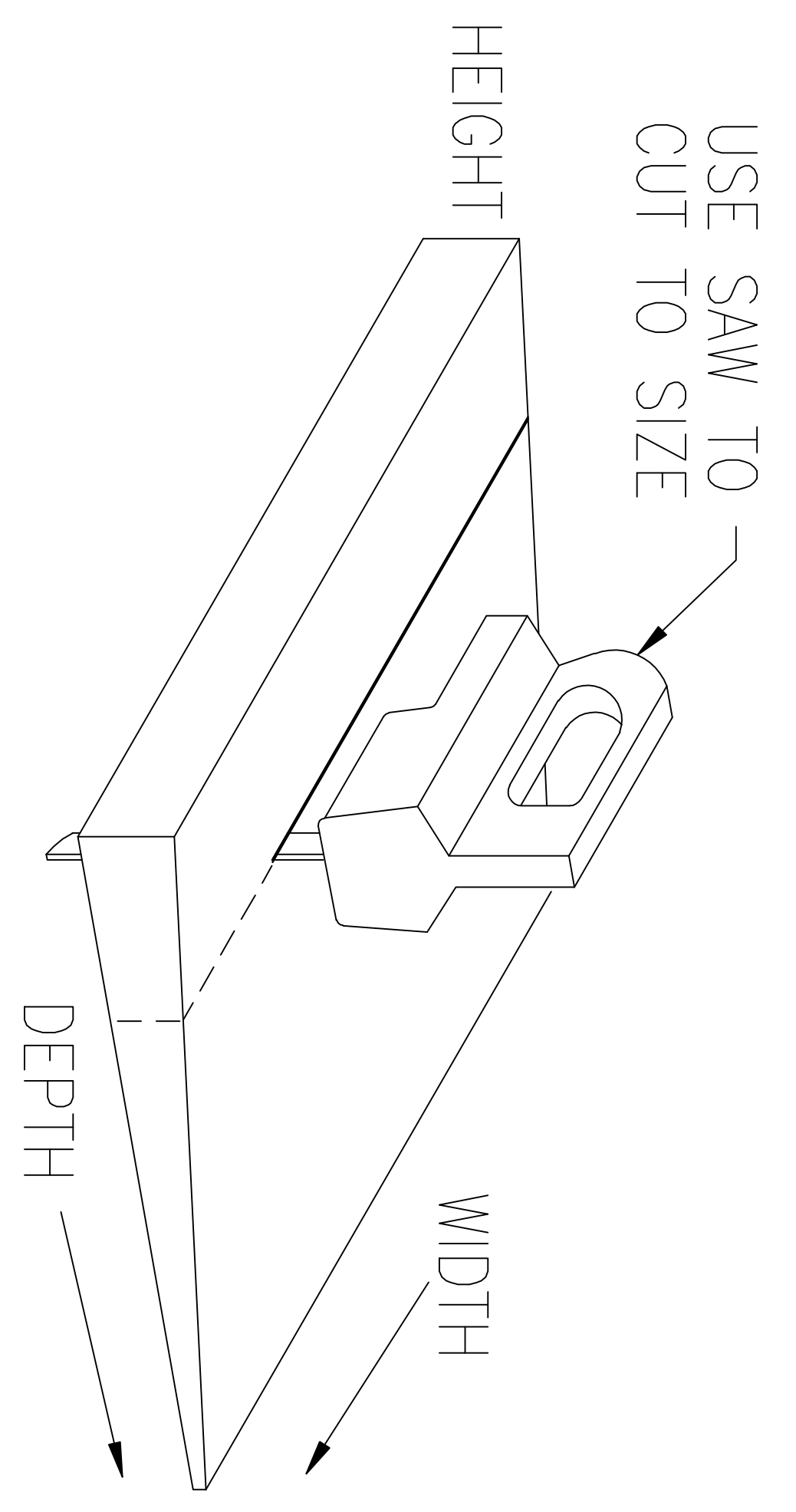

CUTTING TRANSITION FROM ONE THICKNESS TO THE NEXT

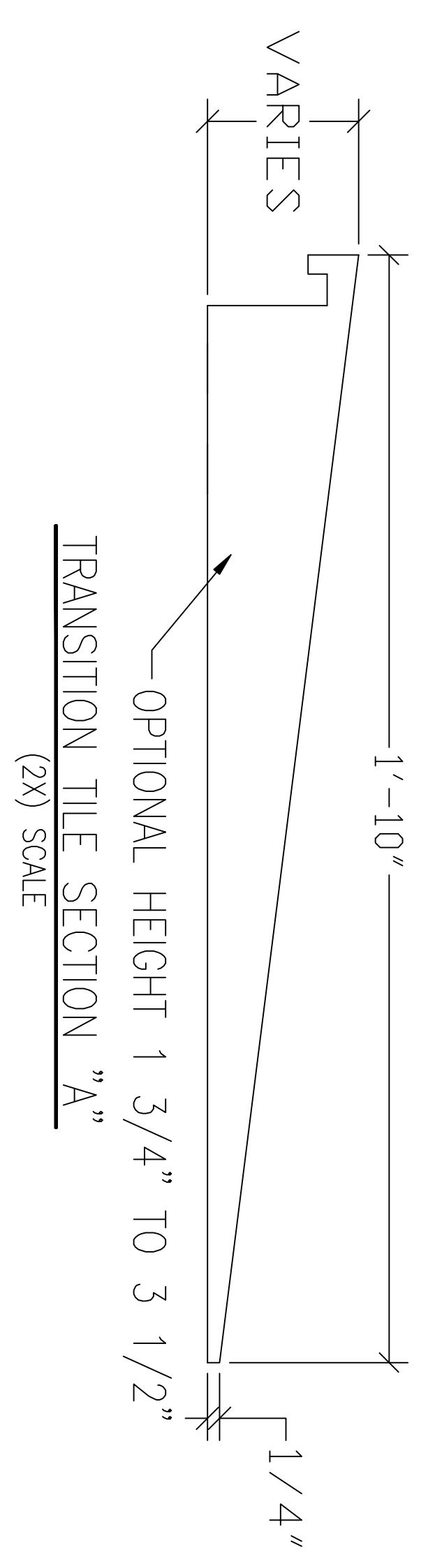
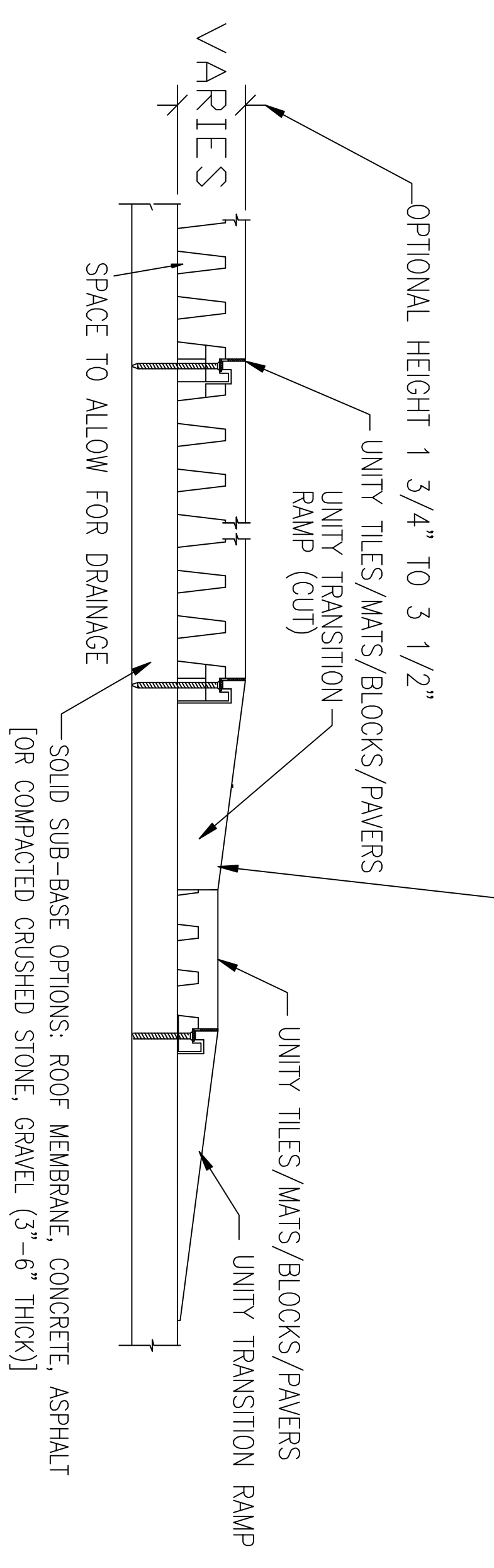

SUB-SURFACING/BASE OPTIONS - RAISED SURFACE W/ TRANSITION

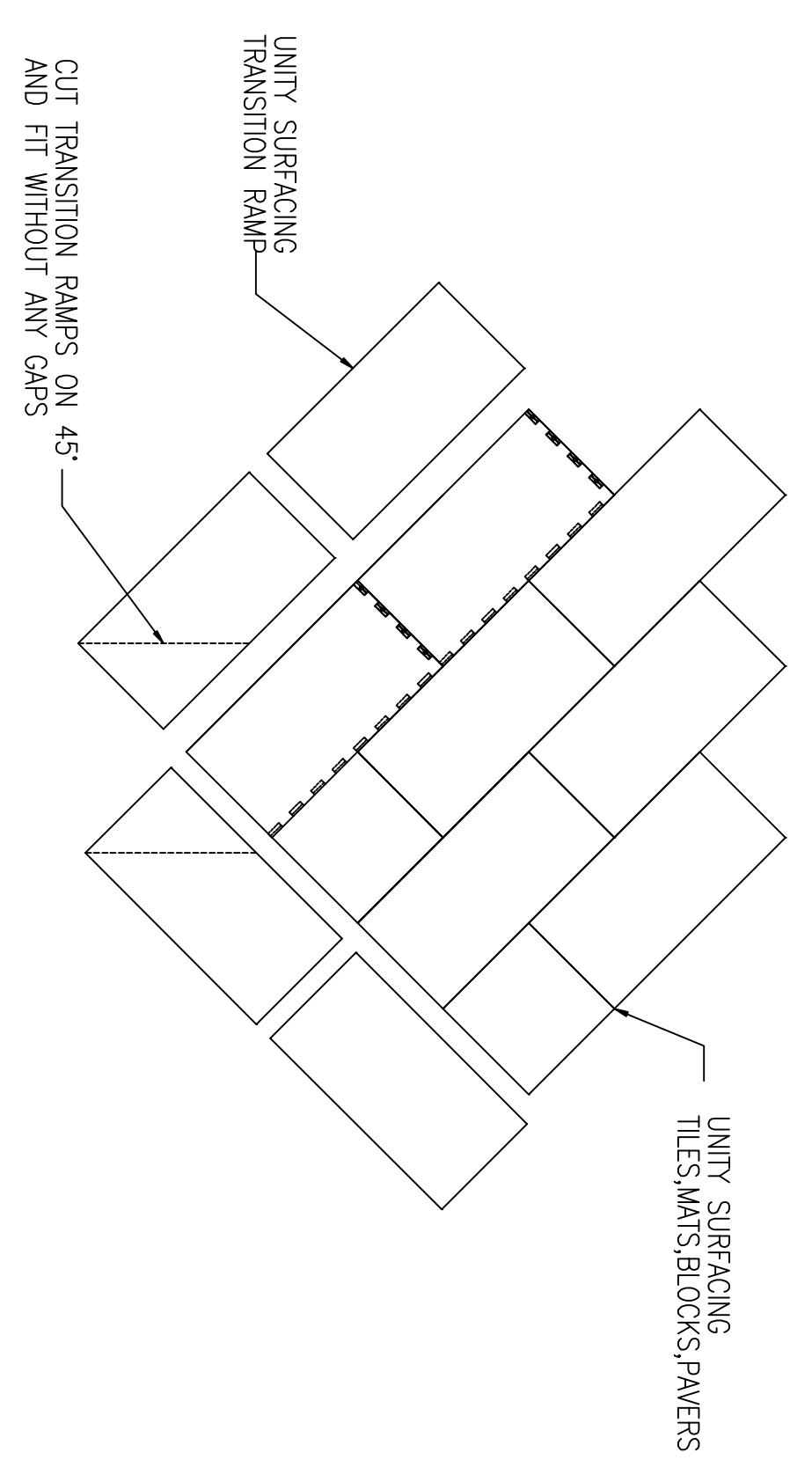

INSIDE CORNER TRANSITION RAMP DETAIL (PRE CONSTRUCTION)

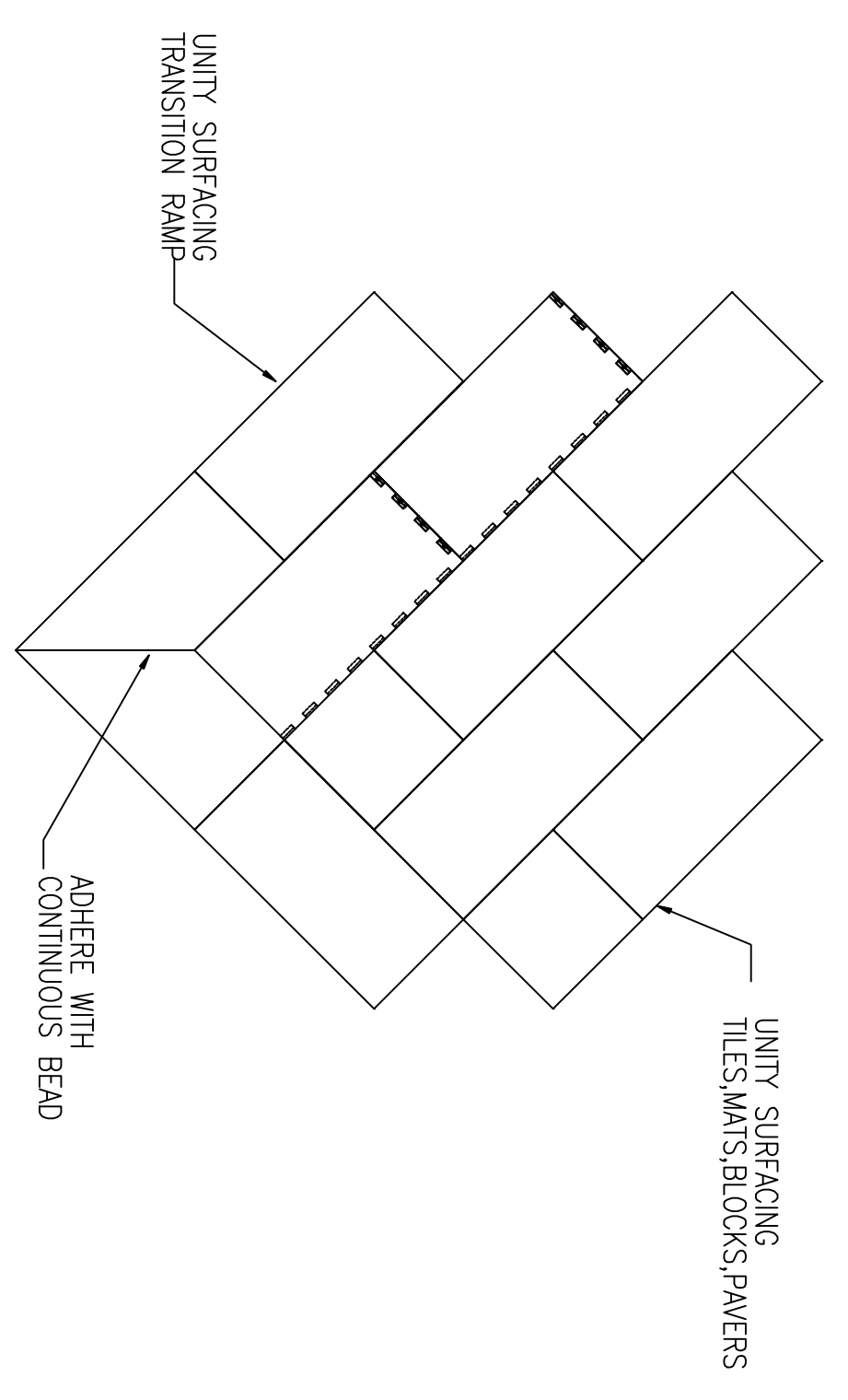

OUTSIDE CORNER TRANSITION RAMP DETAIL (POST CONSTRUCTION)

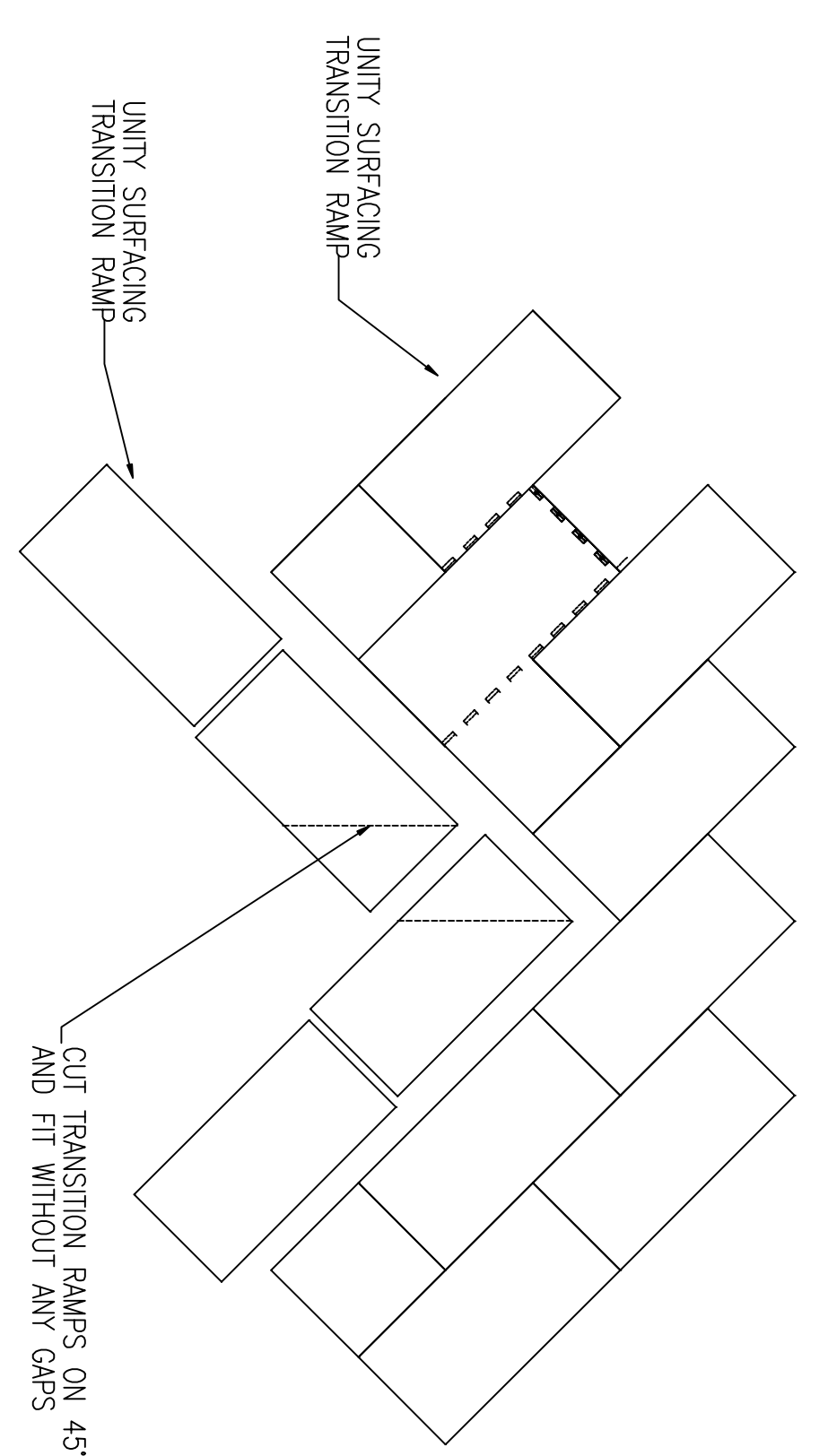

INSIDE CORNER TRANSITION RAMP DETAIL (PRE CONSTRUCTION)

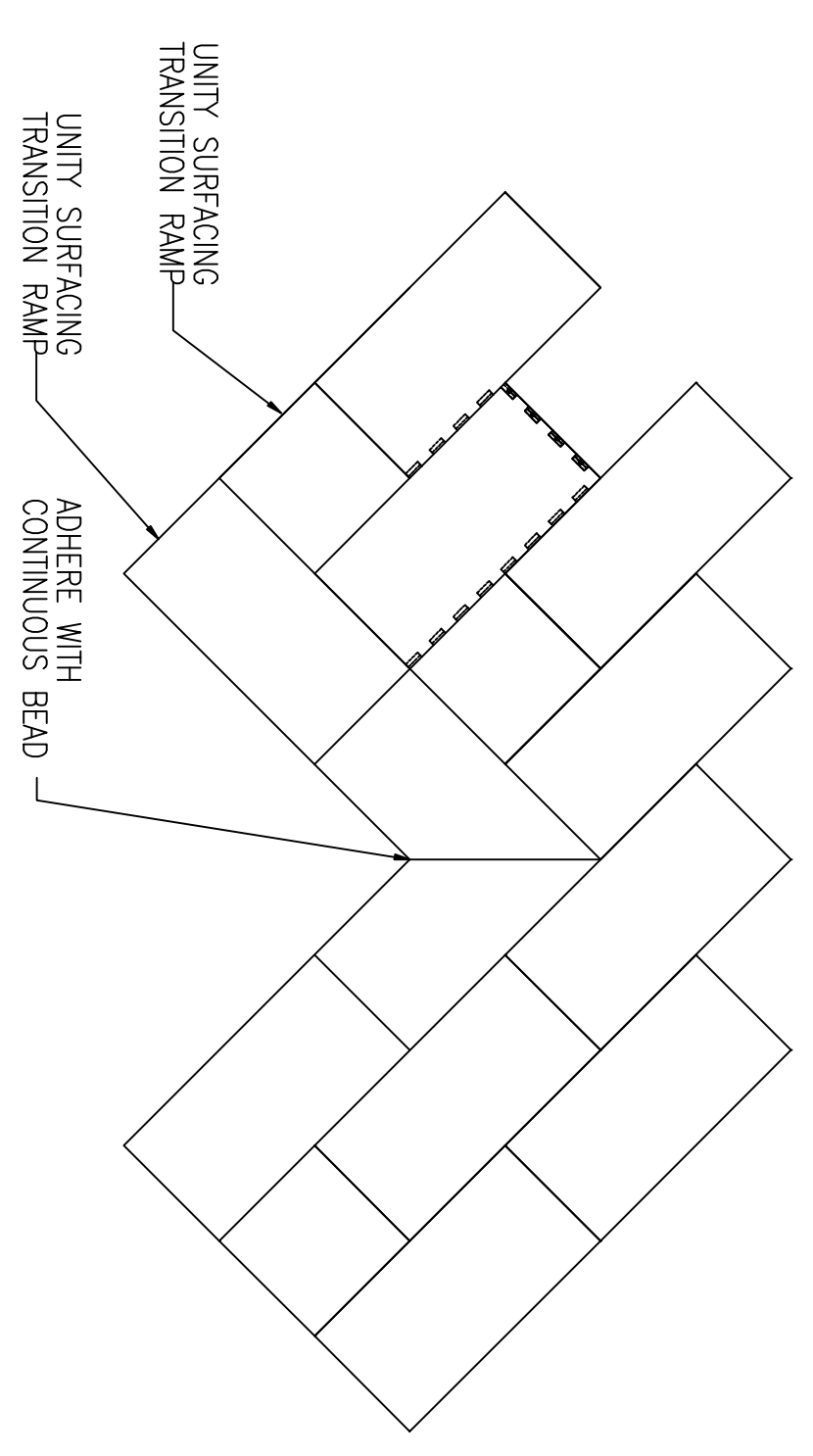

INSIDE CORNER TRANSITION RAMP DETAIL (POST CONSTRUCTION)

General Notes

TRANSITION RAMP CUTTING FROM ONE THICKNESS TO THE NEXT DETAIL INSIDE AND OUTSIDE CORNER DETAIL

No.	Revision/Issue	Date
1	ORIGINAL	7/1/16
2	UPDATE	8/26/19
3	UPDATE	1/23/20

**UNITY CREATIONS LTD./UNITY SURFACING SYSTEMS**

SALES & MARKETING:  
56 BLOOMINGDALE RD.  
HICKSVILLE, NY 11801

T: (1-877) 41-UNITY  
F: (845) 246-1700  
E-MAIL: [productinfo@surfacingystems.com](mailto:productinfo@surfacingystems.com)  
WEB: [www.surfacingystems.com](http://www.surfacingystems.com)

**MANUFACTURING PLANT:**  
UNITY CREATIONS, LTD.  
3997 ROUTE 9W (P.O. BOX 9)  
SAUGERTIES, NY 12477

PROJECT:

Project	Sheet
Date	
Scale	NOTED