

NOTE: THICK END CAN COME WITH FEMALE INTERLOCKS OR BUTT JOINT

TOP VIEW OF UNITY SURFACING SYSTEMS TRANSITION RAMP (LONG)

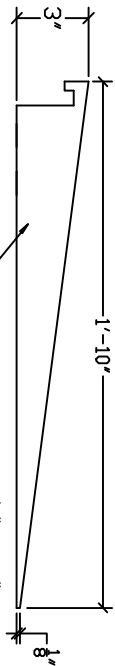

TRANSITION TILE SECTION "A-A"  
(2X) SCALE

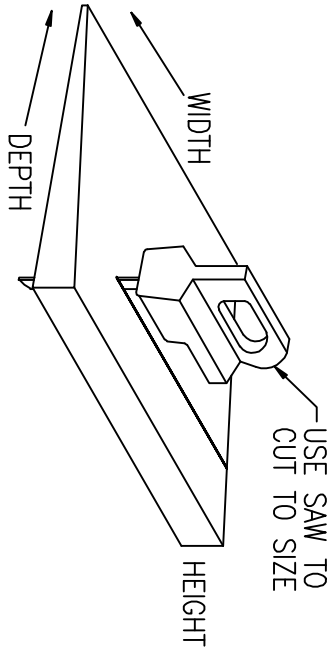

CUTTING TRANSITION FROM ONE THICKNESS TO THE NEXT

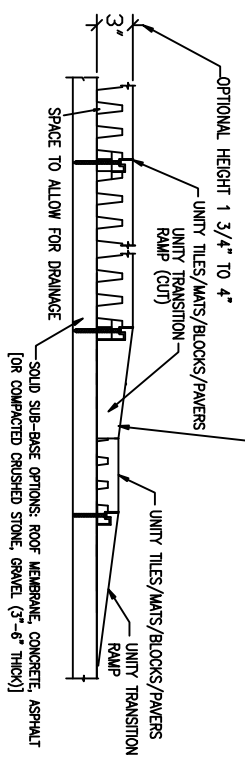

SUB-SURFACING/BASE OPTIONS - RAISED SURFACE W/ TRANSITION

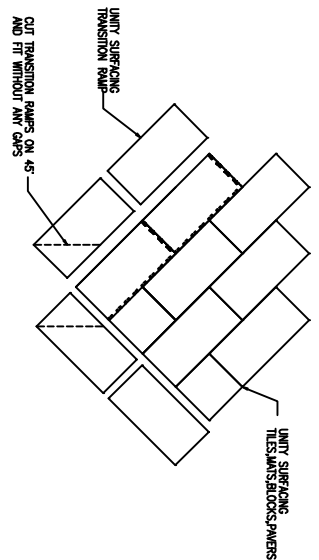

OUTSIDE CORNER TRANSITION RAMP DETAIL (PRE CONSTRUCTION)

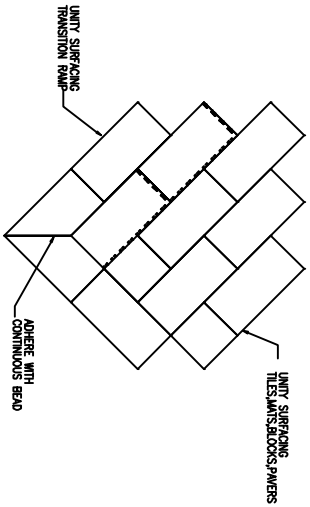

OUTSIDE CORNER TRANSITION RAMP DETAIL (POST CONSTRUCTION)

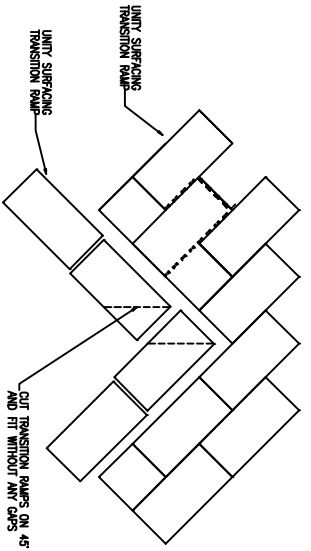

INSIDE CORNER TRANSITION RAMP DETAIL (PRE CONSTRUCTION)

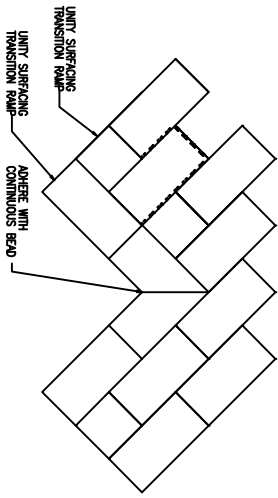

INSIDE CORNER TRANSITION RAMP DETAIL (POST CONSTRUCTION)

TRANSITION RAMP CUTTING DETAILS FROM ONE THICKNESS TO THE NEXT AS WELL AS INSIDE & OUTSIDE CORNERS

NO.	1	ORIGINAL	7/1/16
REV.		REVISION/REASON	DATE

UNITY CREATIONS LTD./UNITY SURFACING SYSTEMS  
 SALES & MARKETING:  
 56 BLOOMINGDALE RD,  
 HICKSVILLE, NY 11801  
 T: (1-877) 41-UNITY  
 F: (845) 246-1700  
 E-MAIL: [productinfo@surfacingystems.com](mailto:productinfo@surfacingystems.com)  
 WEB: [www.surfacingystems.com](http://www.surfacingystems.com)

MANUFACTURING PLANT:  
 UNITY CREATIONS LTD.  
 5007 ROUTE 9N BOX 9  
 SAUGERTOWN, NY 12477

PROJECT:

Address	
Phone	
Other	

Project Name	
Client Name	
Other	